



40W Single Output AC Dimmable LED Power Supply

PCD-40 series



■ Features :

- AC phase-cut dimming
- Work with leading edge and trailing edge TRIAC dimmers
- Built-in active PFC function
- Constant current design
- Protections: Short circuit / Over temperature
- Cooling by free air convection
- Fully isolated plastic case
- IP42 design
- Class II power unit, no FG
- Suitable for indoor LED lighting applications
- 100% full load burn-in test
- Low cost
- High reliability
- 3 years warranty



SPECIFICATION

MODEL	PCD-40-350B	PCD-40-500B	PCD-40-700B	PCD-40-1050B	PCD-40-1400B	PCD-40-1750B	
OUTPUT	RATED CURRENT	350mA	500mA	700mA	1050mA	1400mA	1750mA
	OPERATING VOLTAGE RANGE	70 ~ 108V	45 ~ 80V	34 ~ 57V	22 ~ 38V	17 ~ 29V	13 ~ 23V
	CURRENT ACCURACY	±5.0%					
	RATED POWER	37.8W	40W	39.9W	39.9W	40.6W	40.25W
	RIPPLE & NOISE (max.) Note.1	9.5Vp-p	5.0Vp-p	3.1Vp-p	2.6Vp-p	2.5Vp-p	2.4Vp-p
	NO LOAD OUTPUT VOLTAGE (max.)	118V	100V	63V	50V	35V	35V
	SETUP TIME	500ms / 230VAC at full load					
INPUT	VOLTAGE RANGE	180~295VAC					
	FREQUENCY RANGE	47 ~ 63Hz					
	POWER FACTOR (Typ.)	PF>0.9/230VAC, PF>0.9/277VAC at full load (Please refer to "Power Factor Characteristic" curve)					
	TOTAL HARMONIC DISTORTION	THD< 20% when output loading≥60%(PCD-40-350B loading≥65%)at 230VAC input and output loading≥75% at 277VAC input					
	EFFICIENCY (Typ.)	87%	87%	86%	86%	85%	85%
	AC CURRENT (Typ.)	0.35A/230VAC 0.3A/277VAC					
	INRUSH CURRENT(Typ.)	COLD START 11A (twidth=50μs measured at 50% Ipeak) at 230VAC					
	MAX. No. of PSUs on 16A CIRCUIT BREAKER	47 units (circuit breaker of type B) / 47 units (circuit breaker of type C) at 230VAC					
LEAKAGE CURRENT	<0.5mA / 240VAC						
PROTECTION	SHORT CIRCUIT	Hiccup mode, recovers automatically after fault condition is removed.					
	OVER TEMPERATURE	Shut down o/p voltage, auto-recovery					
ENVIRONMENT	WORKING TEMP.	-30 ~ +50°C (Refer to "Derating Curve")					
	WORKING HUMIDITY	20 ~ 95% RH non-condensing					
	STORAGE TEMP., HUMIDITY	-40 ~ +80°C, 10 ~ 95% RH					
	TEMP. COEFFICIENT	±0.03%/°C (0 ~ 50°C)					
	VIBRATION	10 ~ 500Hz, 2G 12min./1cycle, period for 72min. each along X, Y, Z axes					
SAFETY & EMC	SAFETY STANDARDS	ENEC EN61347-1, EN61347-2-13 independent, EN62384, IP42 approved					
	WITHSTAND VOLTAGE	I/P-O/P:3.75KVAC					
	ISOLATION RESISTANCE	I/P-O/P:100M Ohms / 500VDC / 25°C / 70% RH					
	EMC EMISSION	Compliance to EN55015, EN61000-3-2 Class C ; EN61000-3-3					
	EMC IMMUNITY	Compliance to EN61000-4-2,3,4,5,6,8,11, EN61547, light industry level(Surge 2KV), criteria B					
OTHERS	MTBF	362.331Khrs min. MIL-HDBK-217F (25°C)					
	DIMENSION	128*60*31.5mm (L*W*H)					
	PACKING	0.23Kg;30pcs/7.9Kg/0.58CUFT					
NOTE	<ol style="list-style-type: none"> 1. Ripple & noise are measured at 20MHz of bandwidth by using a 12" twisted pair-wire terminated with a 0.1uf & 47uf parallel capacitor. 2. Direct connecting to LEDs is suggested, but is not suitable for using additional drivers. 3. To fulfill requirements of the latest ErP regulation for lighting fixtures, this LED power supply can only be used behind a switch without permanently connected to the mains. 						



40W Single Output AC Dimmable LED Power Supply

PCD-40 series

■ Mechanical Specification

Case No.:PCD40A Unit:mm

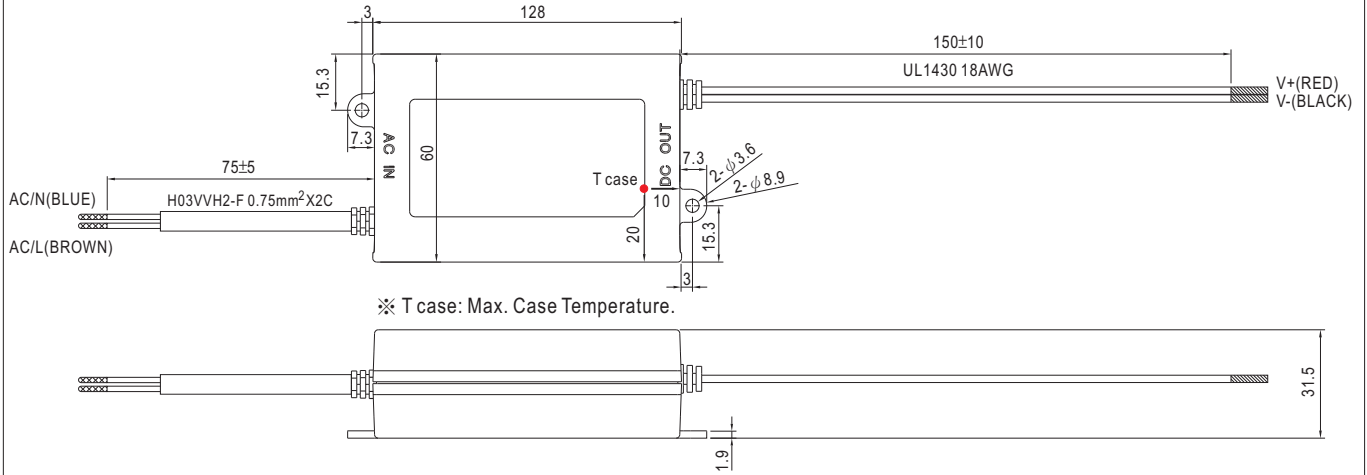

■ Block Diagram

fosc :60KHz(230VAC)

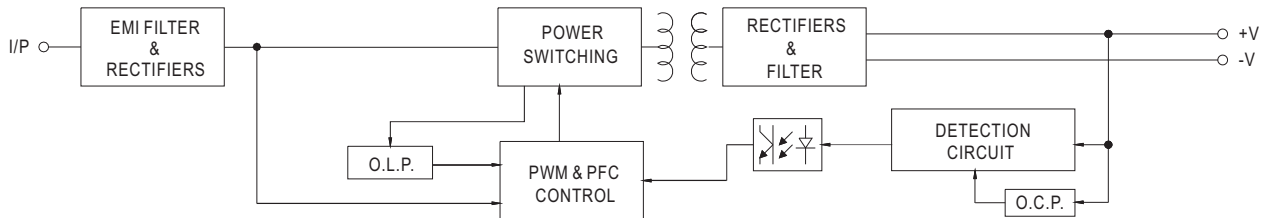

■ Derating Curve

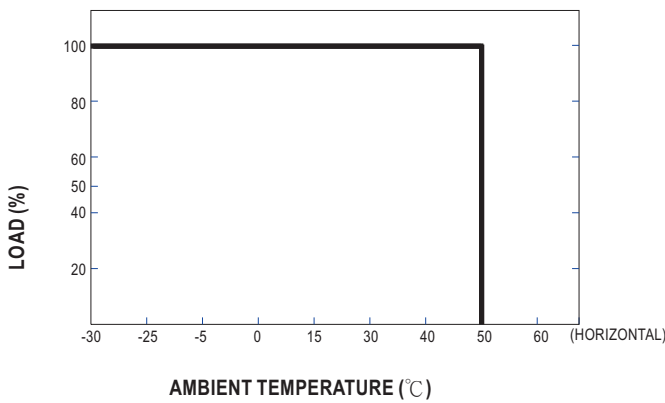

■ Static Characteristics

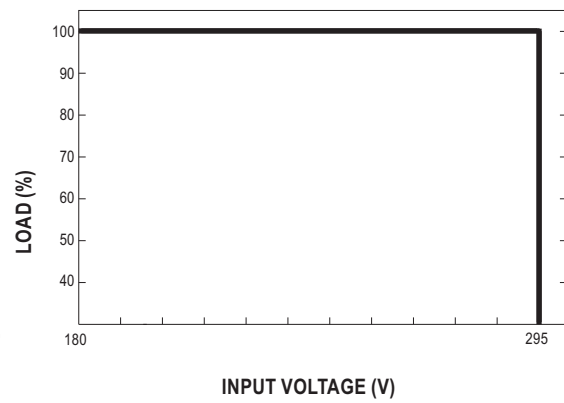



Power Factor Characteristic

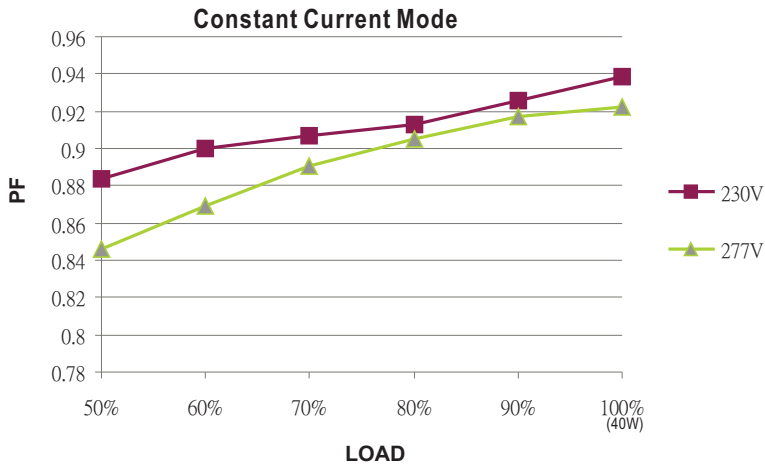

EFFICIENCY vs LOAD (PCD-40-500B)

PCD-40 series possess superior working efficiency that up to 87% can be reached in field applications.

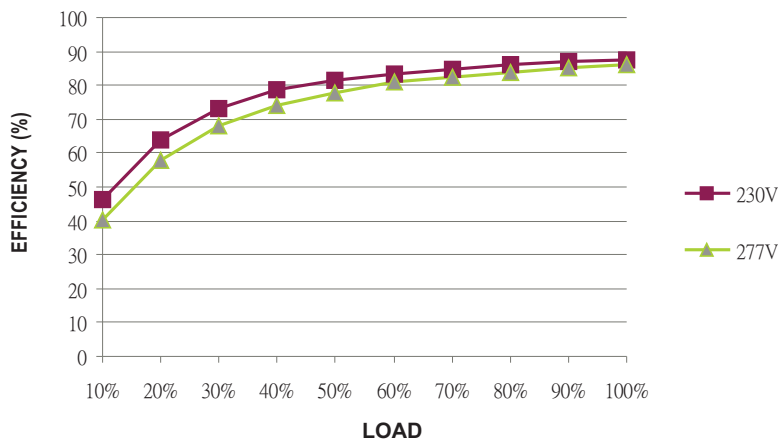



■ AC Dimming Operation

⊙ The following diagram depicts a typical installation utilizing the PCD-40 :

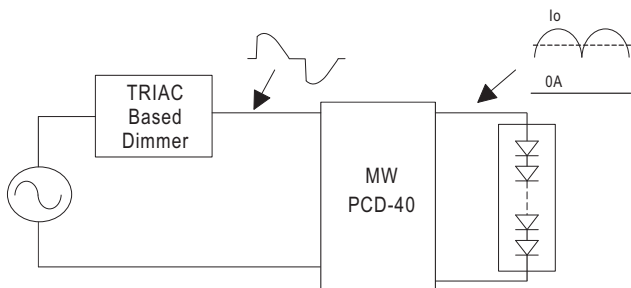

Under direct driving, the power supply will work in "constant current mode (CC)" and output voltage of the power supply will be clamped by sum of forward voltage (V_F) of the LED strip.

⊙ Dimmer Compatibility Chart

Manufacturer	Dimmer Model	
LUTRON	SKYLARK SF-12P-277	(277VAC / 60Hz)
LUTRON	DVF-103P-277	(277VAC / 60Hz)
JUNG	Licht-Management 225 TDE	(230VAC / 50Hz)
JUNG	Licht-Management 225 NV DE	(230VAC / 50Hz)
BERKER	Tronic-Drehdimmer 286710	(230-240VAC / 50Hz)
CLIPSAL	32E450UDM	(220-240VAC / 50Hz)
CLIPSAL	NO 32E450TM	(220-240VAC / 50Hz)
CLIPSAL	NO 32E450LM	(220-240VAC / 50Hz)
CLIPSAL	Cat 400T	(230-240VAC / 50Hz)

Conduction angle: 30 degrees(min.) / 180 degrees(max.)